



Hello all,

Finally, here it is. The service manual of the famous Technics SL1200Mk2 turntables. If you didn't noticed already, some pages are missing, but those pages weren't very interesting or they were in German language. And that is the last thing you want ;-)

Some pages have to be layed next to each other to get the whole picture, like pages 13, 14 and 16 and 17.

Don't come complaining about the quality of the scanned pictures, because at www.1200s.com you have to pay 20 USDollars for it and now it is for free. Don't tell anyone. ;-)

We hope you can use the service manual for whatever purpose!
have a nice time..

Robert Jan
www.backspin.org

Service Manual

Turntable System

Supplement
New

hart
Schonk
SFUP122-23
SFUP122-24
SFUM102NO4

SL-1200MK2

[M], [MC],

[E], [EK], [XL], [EG], [EB], [EH],

[EF], [EI], [XA], [PA], [PE], [PC]

SL-1210MK2

[E], [EG], [EH]



*SL-1200MK2 is the model for silver type.

*SL-1210MK2 is the model for black type of SL-1200MK2.

Area

- * [M] is available in the U.S.A.
- * [MC] is available in Canada.
- * [E] is available in Switzerland and Scandinavia.
- * [EK] is available in United Kingdom.
- * [XL] is available in Australia.
- * [EG] is available in F.R. Germany.
- * [EB] is available in Belgium.
- * [EH] is available in Holland.
- * [EF] is available in France.
- * [EI] is available in Italy.
- * [XA] is available in Southeast Asia, Oceania, Africa, Middle Near East and Central South America.
- * [PA] is available in far East PK.
- * [PE] is available in European Military.
- * [PC] is available in European Audio Club.

Please use this manual together with the service manual for Model No. SL-1200MK2/1210MK2.

English

Specifications

Specifications are subject to change without notice for further improvement.
Weight and dimensions shown are approximate.

General

Power supply:	120V, AC 60 Hz (For [M], [MC] areas) ~110-120/220-240V, 50 or 60 Hz (For other areas)
Power consumption:	14 W (For [M], [MC] areas) 13.5 W (For other areas)
Dimensions: (W x H x D)	45.3 x 16.2 x 36 cm (17.27/32" x 6.19/54" x 14.11/54")
Weight:	12.5 kg (27.6 lb)

Turntable section

Type:	Quartz direct drive Manual turntable
Drive method:	Direct drive
Motor:	Brushless DC motor

Turntable platter:	Aluminum diecast Diameter 33.2 cm (13.0/54") Weight 2 kg (4.4 lb)
Turntable speeds:	33-1/3 rpm and 45 rpm
Starting torque:	1.5 kg · cm (1.3 lb · in)
Build-up characteristic:	0.7 s, from standstill to 33-1/3 rpm
Braking system:	Electronic brake
Wow and flutter:	0.01% WRMS* 0.025% WRMS (JIS C5621) ± 0.035% peak (IEC 98A Weighted)

* This rating refers to turntable assembly alone, excluding effects of record, cartridge or tonearm, but including platter.
Measured by obtaining signal from built-in frequency generator of motor assembly.

Rumble:	-55 dB (IEC 98A Unweighted) -78 dB (IEC 98A Weighted)
---------	--

Matsushita
Service Call
30 Meadoro
Saitama, J.

Panasonic-CENTRE NEDERLAND
servicom bv

Technics

Pan
Matsushita Elm
1-2, Ichome, Shiba

Balie Service Manual



SL-1200MK2/1210MK2

■ Tonarm section

Type:	Universal
Effective length:	230 mm (9-1/16")
Arm height adjustment range:	0 - 6 mm
Overhang:	15 mm (19/32")
Effective mass:	12 g (without cartridge)
Offset angle:	22°
Friction:	Less than 7 mg (lateral, vertical)
Tracking error angle:	Within 2°32' (at the outer groove of 30 cm (12") record Within 0°32' (at the inner groove of 30 cm (12") record)

Stylus pressure adjustment range:	0 - 2.5 g
Applicable cartridge weight range:	6 - 10 g
	13.5 - 17.5 g (including headshell)
(with auxiliary weight):	9.5 - 13 g
	17 - 20.5 g (including headshell)
(with shell weight):	3.5 - 6.5 g
	11 - 14 g (including headshell)
Headshell weight:	7.5 g

Notes

- To improve the performance of SL-1200MK2/1210MK2, the bottom structure and circuit are changed in the course of production.
- After the change, SL1200MK2-A/1210MK2-A is indicated in the name plate as the model of the set. It is discriminated from before-change set by -A. Also, check that the present change is of the sets after the change mark  shown in the serial No. sheet attached to the bottom and carton box.
- This supplement service manual contains the bottom plate disassembly procedure, change part No., circuit diagram, P.C.B. and block diagrams. The other contents are the same as for the service manual of SL-1200MK2/1210MK2 already issued.
- Sets with cartridge (EPC-207C) are included in those for same area.
- Since the power transformer fitting method is different for sets with serial number sheet change mark , refer to the development plan on page 8.



Serial No. sheet



Change mark

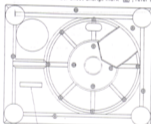

Serial No. sheet

Deutsch

TECHNISCHE DATEN

Änderungen der technischen Daten vorbehalten.
Die angegebenen Gewichts- und Abmessungsdaten sind ungefähre Werte.

■ Allgemeine Daten

Bromversorgung:	~ 110-120/220-240 V, 50/60 Hz
	Wechselstrom
Leistungsaufnahme:	13,5 W
Abmessungen:	
(B x H x T):	45,3 x 16,2 x 36 cm
Gewicht:	12,5 kg

■ Plattenspieler

Typ:	Manueller Quers-Direkttrieb-Plattenspieler
Antrieb:	Direkttrieb
Motor:	Kollektorloser Gleichstrommotor
Plattenteller:	Aluminium-Spritzguß Durchmesser 33,2 cm Gewicht 2 kg

Plattenteller-Drehzahl:	33-1/3 und 45 U/min
Anlaufdrehmoment:	1,5 kg · cm
Drehzahl-Hochlaufzeit:	0,7 s vom Stillstand auf 33-1/3 U/min
Bremssystem:	Elektronische Bremse
Gleichlaufschwankungen:	0,01% WRMS* 0,025% WRMS (JIS C5621) ± 0,035% Spitze (IEC 96A bewertet)

* Diese Kennzeichnung bezieht sich auf das Laufwerk-Bauteil allein, ausschließlich Einflüsse von Schallplatte, Tonabnehmer oder Tonarm, aber einschließlich Plattenteller.
Gemessen anhand von Signalen vom eingebauten Frequenzgenerator des Motorbauteils.

Rumpel-Geräuschspannungszustand:	-50 dB (IEC 96A unbewertet) -78 dB (IEC 96A bewertet)
----------------------------------	--

● How to remove the hinge case

1. Remove the bottom cover. (Refer to "How to remove the bottom cover".)
2. Remove the 4 setscrews (Fig. 2: ⑤) of the hinge case bracket.
3. Remove the 4 setscrews (Fig. 2: ⑥) of the hinge case.

Note: The other disassembly procedure are the same as for before-change sets.

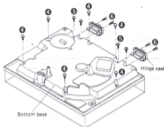

Fig. 2

REPLACEMENT PARTS LIST

Notes:

1. This parts list mentions only the difference between before and after change of SL-1200MK2/1210MK2.
2. ⑤-marked parts are used only for SL-1210MK2 (black type). And ⑥-marked parts are used for SL1200MK2 (silver type).
3. Parts other than ⑤- and ⑥-marked are used for both SL-1210MK2 and SL-1200MK2.
4. The "③" mark is service standard parts and may differ from production parts.

Area

- [M] is available in the U.S.A.
- [MC] is available in Canada.
- [E] is available in Switzerland and Scandinavia.
- [EK] is available in United Kingdom.
- [XL] is available in Austria.
- [GL] is available in F.R.G., Germany.
- [EB] is available in Belgium.
- [EH] is available in Holland.
- [EF] is available in France.
- [E] is available in Italy.
- [XA] is available in Southeast Asia, Oceania, Africa, Middle Near East and Central South America.
- [PA] is available in far East PK.
- [PE] is available in European Military.
- [PC] is available in European Audio Club.

The Submitted only for ID-11

Ref. No.	Change of Part No.		Part Name & Description	Per Set (Pcs.)	Remarks
	SL-1200MK2 (Before Change)	SL-1200MK2/1210MK2 (After Change)			
INTEGRATED CIRCUIT					
IC302	5V1C40118P	MN4011B	NAND Gate	1	
TRANSISTOR					
Q1	2SD389A-Q	2SD1265	Regulator	1	
DIODES					
D1	5VD51R8A40	5VD51R8A20Z	Rectifier	1	△
Q201_202	5VDSR-105C	5VDP43025-9	Speed Indicator	2	
Q203 ~ 206	5VDSBR95055	5VDSLH64V73	Strobe	4	
D401	5VDGL-8P02	5VDSL-8N02	Pitch Indicator	1	
CRYSTAL					
X301	5VQU306115	5VQMS4193	4.193 MHz Oscillator	1	
VARIABLE RESISTORS					
VR301	EVMH02A00853	EVMH1GA008Z3	Pitch Control Adjustment, 2kΩ (E)	1	
VR303	EVB05C19A8E	SFDZ122N11	Pitch Control	1	
SWITCHES					
S203	SFOS586GL13C	SFDS5901GL13	Start/Stop	1	
S901	SFOS586GL13S	SFDS586GL13P	Power	1	△
TRANSFORMER					
T1	SLT860E78	SLT860T13A [M]	Power Source	1	△
T1	SLT860E31C	SLT860T14C [MC]	Power Source	1	△
T1	SLT79900	SLT860TE13A [Other area]	Power Source	1	△

Ref. No.	Change of Part No.		Part Name & Description	Per Set (Pos.)	Remarks
	SL-1200MK2 (Before Change)	SL-1200MK2/1210MK2 (After Change)			
RESISTORS					
R4	ERD25FJ561	ERD25FJ471	Carbon, 1/8W, 470Ω	1	⑤
R209	ERD25TJ154	ERD25TJ334	Carbon, 1/8W, 330kΩ	1	⑤
R211	ERD25FJ103	ERD25FJ472	Carbon, 1/8W, 4.7kΩ	1	⑤
R212	ERD25FJ121	ERD25FJ151	Carbon, 1/8W, 150Ω	1	⑤
R222	Addition	ERD25FJ391	Carbon, 1/8W, 390Ω	1	⑤
R301	ERD25CKP3301	ERD25CKP2701	Metal Film, 1/4W, 2.7kΩ	1	⑤
R304	ERD25FJ152	ERD25FJ561	Carbon, 1/4W, 560Ω	1	⑤
R401	Addition	ERD50FJ152	Carbon, 1/2W, 1.5kΩ	1	⑤
R601	ERD25FJ4R7	ERD50FJ4R7	Carbon, 1/2W, 4.7Ω	1	△ ⑤
CAPACITORS					
C5, 6	Addition	ECQM1223KZ	Polyester, 125V, 0.022μF	1	△
C104 ~ 107	ECQM1H104KZ	ECQM1H104JZ	Polyester, 50V, 0.1μF	4	⑤
C109, 110	ECQM1H104KZ	ECQM1H104JZ	Polyester, 50V, 0.1μF	2	⑤
C111	ECQM1H562KZ	ECQM1H562JZ	Polyester, 50V, 0.0056μF	1	⑤
C204	ECQM1H473KZ	ECQM1H473JZ	Polyester, 50V, 0.047μF	1	⑤
C210	ECQM1H224KZ	ECQM1H224JZ	Polyester, 50V, 0.22μF	1	⑤
C211	ECQM1H473KZ	ECQM1H473JZ	Polyester, 50V, 0.047μF	1	⑤
C217 ~ 219	Addition	ECQD1H104ZF	Ceramic, 50V, 0.1μF	1	⑤
C301	ECQK1123FZ	ECQK1335JZ	Polyester, 125V, 0.033μF	1	⑤
C302	ECQK1123FZ	ECQK1662JZ	Polyester, 125V, 0.0066μF	1	⑤
C305	ECQM1H122KZ	ECQM1H122JZ	Polyester, 50V, 0.0012μF	1	⑤
CABINET AND CHASSIS PARTS					
9	SFUP122-12	Deletion	0	
10	SFAC122-01	SFAC122-01	Cabinet (Silver)	1	○
		SFAC124901	Cabinet (Black)	1	⊗
25	SFXB122-02	SFXB122-06	Box, Drive	1	
33	SFGA001-02	SFGA122-03	Spring	1	
36	SFUP025-01	SFUP122-16 (M, MC, PA, PE, PC)	Bracket, AC Cord	1	
	SFUP025X01	SFUP122X01 (Other areas)	Bracket, AC cord	1	
38	SFUP132-03	SFGC122-03	Cushion	2	
40	SFUP122-10	Deletion	0	
42	SFKK122-03	SFKK122-03	Plate (Silver)	1	
		SFKK124501	Plate (Black)	1	
48	SFAU122-01	SFAU122-02	Bottom Base	1	
48-1	Addition	SFAU122-03	Bottom Cover	1	
49	SFUP122-05	SFUP122-23	Supporter (A), Hinge	2	
50	SFUP122-04	SFUP122-24	Supporter (B), Hinge	2	
51	SFUM170-07	SFUMM02N04	Case, Hinge	2	
55	SFNN122M01	SFNN122M10 (M)	Name Plate	1	○
	SFNN122C01	SFNN122C10 (MC)	Name Plate	1	○
	SFNN122901	SFNN122910 (E)	Name Plate	1	○
	SFNN122L01	SFNN122L10 (EK, XL)	Name Plate	1	○
	SFNN122X01	SFNN122X10 (XA)	Name Plate	1	○
	Addition	SFNN122P10 (PA, PE)	Name Plate	1	○
	Addition	SFNN122P11 (PC)	Name Plate	1	○
	SFNN122N01	SFNN122N10 (Other areas)	Name Plate	1	○
	Addition	SFNN124510 (E)	Name Plate	1	⊗
	Addition	SFNN124G10 (EG, EH)	Name Plate	1	⊗
56	SFXD122-01	Deletion	0	
57	SFXD122-02	Deletion	0	
58	SFAT122-01A	SFATM02N01A	Hinge	1	

SL-1200MK2/1210MK2

Ref. No.	Change of Part No.		Part Name & Description	Per Set (Pcs.)	Remarks
	SL-1200MK2 (Before Change)	SL-1200MK2/1210MK2 (After Change)			
TONEARM PARTS					
62	SFPA18201K	SFPA18201K	Tonearm Air'y (Silver)	1	○
	SFPA18203K	SFPA18203K	Tonearm Air'y (Black)	1	⊗
79	SFK817201S	SFK817204E	Ring Arm Bear Operation	1	
82	SFGK130-01	SFGK130-01	Cap (Silver)	1	○
		SFGK133601	Cap (Black)	1	⊗
ACCESSORIES					
A1	SFNU122M01	SFNU122M06 [M]	Instruction Book	1	
	SFNU122C01	SFNU122C06	Instruction Book	1	
	SFNU122B01	SFNU122B01 [E]	Instruction Book	1	
	SFNU122G01	SFNU122G01 [EK]	Instruction Book	1	
	Addition	SFNU122P01 [PA, PE, PC]	Instruction Book	1	
	SFNU122X01	SFNU122X01 [Other areas]	Instruction Book	1	
A2	SFWE010	SFWE123-01	45 Adaptor	1	
PACKING PARTS					
P1	SFHP122C01	SFHP122C02 [MC, EF]	Carton Box (Silver)	1	○
	SFHP122M01	SFHP122M02 [Other areas]	Carton Box (Silver)	1	○
		SFHP124B02	Carton Box (Black)	1	⊗
P9	Addition	SF310B3	Polyethylene Bag, Accessories	2	
P10	Addition	SF115	Polyethylene Bag, Shell Weight	1	
P11	Addition	SFH2003M01	Polyethylene Bag, Dust Cover	3	
P12	Addition	SFH2123-01	Polyethylene Bag, 45 Adaptor	1	
P13	Addition	SF189	Polyethylene Bag, Cords	2	

■ ADJUSTMENT POINTS

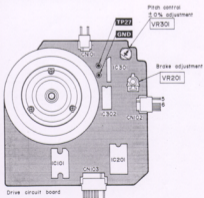

Fig. 3 (Abb. 3)

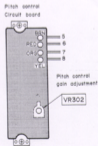

Fig. 4 (Abb. 4)

Note



MEASUREMENTS AND ADJUSTMENTS English

• Conditions of set, and instruments used

1. Remove the panel cover.
2. Remove the bottom cover (when adjusting the pitch control gain).
3. Frequency counter
4. Tester

	Adjustment	Connection	Parts adjusted	Procedure
1	Pitch control \pm 0% adjustment	Frequency counter (+) – TP27 (–) – Earth point	VR301 (Fig. 3)	<ol style="list-style-type: none"> 1. Connect the frequency counter and turn the power supply ON. 2. Set the pitch control knob to "0". (Indicator lights up.) 3. Adjust VR301 so that the frequency is 262.08 kHz \pm 0.05 kHz.
2	Pitch control gain adjustment	Tester (+) – CN102 terminal ⑤ (–) – CN102 terminal ⑥	VR302 (Fig. 4)	<ol style="list-style-type: none"> 1. Set the pitch control knob to "0". 2. Pull out the connector CN102 of drive P.C.B. 3. Connect the tester to terminals ⑤ and ⑥ of connector CN102 on the pitch control P.C.B. side. 4. Adjust VR302 so that the resistance value of the tester is 2.7 kΩ \pm 0.1 kΩ.
3	Brake adjustment	—————	VR201 (Fig. 3)	<ol style="list-style-type: none"> 1. Adjust VR201 so that the rotation at 33 r.p.m. stops within the angle of 90° ~ 120° after depressing the stop button.

MESSUNGEN UND JUSTIERUNGEN Deutsch

• Zustand des Gerätes und zu verwendende Instrumente

1. Die Abdeckplatte entfernen.
2. Die Bodenabdeckung entfernen (wenn die Drehzahlregelungs-Verstärkung justiert werden soll).
3. Frequenzzähler
4. Prüfgerät

	Justierung	Anschlüsse	Zu justierender Teile	Vorgehen
1	\pm 0%-Justierung des Drehzahlreglers	Frequenzzähler (+) – TP27 (–) – Massepunkt	VR301 (Abb. 3)	<ol style="list-style-type: none"> 1. Frequenzzähler anschließen und Netzschalter einschalten. 2. Drehzahlreglerknopf auf "0" stellen. (Anzeige leuchtet auf.) 3. VR301 so justieren, daß die Frequenz 262,08 kHz \pm 0,05 kHz beträgt.
2	Justierung der Drehzahlregelungs-Verstärkung	Prüfgerät (+) – CN102 Anschluß ⑤ (–) – CN102 Anschluß ⑥	VR302 (Abb. 4)	<ol style="list-style-type: none"> 1. Den Drehzahlreglerknopf auf "0" einstellen. 2. Steckverbindung CN102 von der Antriebsplatine herausziehen. 3. Prüfgerät an Anschlüsse ⑤ und ⑥ der Steckverbindung CN102 auf der Drehzahlreglerseite der Platine anschließen. 4. VR302 so justieren, daß der Widerstandswert des Prüfgerätes 2,7 kΩ \pm 0,1 kΩ beträgt.
3	Bremsjustierung	—————	VR201 (Abb. 3)	<ol style="list-style-type: none"> 1. VR201 so justieren, daß die Rotation bei 33 UPM innerhalb 90° ~ 120° nach Drücken der Stop-Taste stoppt.

RESISTORS AND CAPACITORS

- Part numbers are indicated on most mechanical parts. Please use this part number for parts orders.
- Important safety notice: Components identified by Δ mark have special characteristics important for safety. When replacing any of these components use only manufacturer's specified parts.
- The "100" mark is service standard parts and may differ from production parts.
- Bracketed indications in Ref. No. column specify the area. Parts without these indications can be used for all area.
- The unit of resistance is Ω (ohm).
K = 1000 Ω , M = 10000 Ω
- The unit capacitance is μ F (microfarad).
P = 10⁻⁶ μ F

Areas

- [M] is available in the U.S.A.
- [MC] is available in Canada.
- [E] is available in Switzerland and Scandinavia.
- [EK] is available in United Kingdom.
- [KL] is available in Australia.
- [GG] is available in F.R. Germany.
- [BB] is available in Belgium.
- [EH] is available in Holland.
- [EP] is available in France.
- [E] is available in Italy.
- [XA] is available in Southeast Asia, Oceania, Africa, Middle Near East and Central South America.
- [PA] is available in Far East PK.
- [PE] is available in European Military.
- [PC] is available in European Audio Club.

Numbering System of Resistor

Example

ERD	25	F	J	101
Type	Wattage	Shape	Tolerance	Value
ERX	2	AN	J	2R2
Type	Wattage	Shape	Tolerance	Value

Resistor type	Wattage	Tolerance
ERD: Carbon	25 : 1/4W	F : $\pm 1\%$
ERG: Metal Oxide	50 : 1/2W	J : $\pm 5\%$
ERD: Metal Film	1A: 1W	
ERX: Metal Film	2A: 2W	

Numbering System of Capacitor

Example

ECKD	1H	102	Z	F
Type	Voltage	Value	Tolerance	Popularity
ECEA	50	M	R47	R
Type	Voltage	Popularity use	Value	Special use

Capacitor Type	Voltage	Tolerance
ECEA : Electrolytic	0J : 6.3V	J : $\pm 5\%$
ECEB : Electrolytic	1C : 16V	K : $\pm 5\%$
ECCD : Ceramic	1E : 25V	M : $\pm 20\%$
ECGM : Polyester	1H : 50V	Z : $\pm 80\%$ - 20%
ECGU : Polyester	1 : 100V	
ECGP : Polyester	1A : 125V	
ECNC : Polyester	4A : 400V	

Ref. No.	Part No.	Value	Ref. No.	Part No.	Value	Ref. No.	Part No.	Value	Ref. No.	Part No.	Value
RESISTORS											
R1	Δ ERD25F050	5.0K	R210	Δ ERD25T180	18K	C10	ECB1H4J471	470	C210	Δ ECGM1H20A2	0.22
R2	Δ ERD25F050	5.0K	R211	Δ ERD25F472	4.7K	C2	ECBA1E030	33	C211	Δ ECGM1H47S2	0.47
R3	Δ ERD25F272	2.7K	R212	Δ ERD25F120	12K	C3	ECBA1E030	33	C212	ECBA1H030	3.3
R4,5	Δ ERD25F472	47 Ω	R213	Δ ERD25F220	22K	C4	ECGM1E03K2	0.033	C213	Δ ECGD1H47K	470P
R101	Δ ERD25F100	10K	R214	Δ ERD25F472	4.7K	C5,6	ECGM1E030	0.033	C214	ECBA1E010	10K
R102	Δ ER1A1A487	4.7	R215	Δ ERD25F100	100K	C101,102	ECBA1E030	33	C215	ECBA1E010	1
R103	Δ ERD25F472	4.7K	R216	Δ ERD25F220	22K	C103	ECBA1E030	33	C216	ECBA1E0470	47
R104	Δ ERD25T473	47K	R217	Δ ERD25F220	22K	C104,105	Δ ECGM1H0A2	0.1	C217,218	Δ C217,218	0.1
R105	Δ ERD25F100	10K	R218	Δ ERD25F100	1K	C106,107	Δ ECGM1H0A2	0.1	C219	ECGD1H0A2P	0.1
R106	Δ ERD25F100	10K	R219	Δ ERD25F202	3.3K	C108	ECBA1E010	100	C201	ECGD1H000A2	0.003
			R220	Δ ERD25F021	22 Ω	C109,110	Δ ECGM1H0A2	0.1	C202	ECGD1H000G2	0.0006
R107	Δ ER1A1A185	1.5	R221	Δ ERD25F471	47 Ω	C111	Δ ECGM1H0E2	0.0006	C203	ECBA1H010	1
R108	Δ ERD25F100	10K	R222	Δ ERD25F081	80K	C112	ECBA1H047	4.7	C204	ECBA1E0100	10
R109,110	Δ ER1A1A487	4.7	R223	Δ ERD25F270	2.7K	C201	ECBA1E030	33	C205	Δ ECGD1H22J2	0.0215
R201	Δ ERD1A0J361	36K	R224	Δ ERD25F471	47 Ω	C202,203	ECBA1H010	1	C206	ECBA1H010	1
R202	Δ ERD25F100	10K	R225	Δ ERD25F082	0.2K	C204	Δ ECGM1H47A2	0.47	Δ 0811M	Δ ECGD1A473M	0.047
R203	Δ ERD25F470	47 Ω	R226	Δ ERD25F272	2.7K	C205	ECBA1E021	22	Δ 0811M	Δ ECGD1A47M	0.047
R204	Δ ERD25F272	2.7K	R227	Δ ERD25F181	18K	C206	ECBA1E010	1	Δ 0811D	Δ ECGD2A473M	0.047
R205	Δ ERD25T124	120K	R228	Δ ERD25F220	22K	C207	Δ ECGD1H01K	100P			
R206	Δ ERD25T180	18K	R229	Δ ERD25F272	2.7K	C208	Δ ECGD1H00K	22P			
R207	Δ ERD25T060	60K	R230	Δ ERD25F100	10K	C209	ECBA1E010	100			
R208	Δ ERD25T204	220K	R231	Δ ERD25F487	4.7						
R209	Δ ERD25T030	330K									

REPLACEMENT PARTS LIST

- Notes:**
- Part numbers are indicated on most mechanical parts. Please use this part number for parts orders.
 - Important safety notice:
Components identified by Δ mark have special characteristics important for safety. When replacing any of these components use only manufacturer's specified parts.
 - Bracketed indications in Ref. No. columns specify the area. Parts without these indications can be used for all areas.
 - The "S" mark is service standard parts and may differ from production parts.
 - The parenthesized numbers in the column of description stand for the quantity per set.
 - \otimes -marked parts are used only for SL-1210MK2 (black type). And \circ -marked parts are used for SL-1200MK2 (silver type).
 - Parts other than \otimes and \circ marked are used for both SL-1210MK2 and SL-1200MK2.

Areas

- [M] is available in the U.S.A.
- [MC] is available in Canada.
- [E] is available in Switzerland and Scandinavia.
- [EK] is available in United Kingdom.
- [KL] is available in Australia.
- [EG] is available in F.R. Germany.
- [EB] is available in Belgium.
- [EH] is available in Holland.
- [EP] is available in France.
- [E] is available in Italy.
- [XA] is available in Southeast Asia, Oceania, Africa, Middle Near East and Central South America.
- [PA] is available in far East FX.
- [PS] is available in European Military.
- [PC] is available in European Audio Club.

Ref. No.	Part No.	Description	Ref. No.	Part No.	Description	Ref. No.	Part No.	Description
INTEGRATED CIRCUITS			CRYSTAL			LAMP		
IC19	AN6673	Tunable Drive	X201	SVCM3193	4.193MHz	PL1	5P1X12-01-X	180va Fluorescent
IC20	AN6682	Tunable Control				TRANSFORMER		
IC21	AN6683	Push Control	VARIABLE RESISTORS			TR1	Δ SL7MC7L3A	Power Source
IC22	MN4219	RAMD Gate	VR201	SV120MA0094	Steep Adjustment	TR2	Δ SL7MC714C	Power Source
TRANSISTORS			VR202	SV120MA0094	Push Control	TR3	Δ SL7MC715E	Power Source
Q1	2SD1205	Regulator	VR301	2VM115A0093	Push Control	FUSES		
Q2,3	2SD2027	Regulator	VR302	SV120MA0094	Push Control	F1(MC)	Δ KB41F12014	125V 1.2A
Q201	2SD1845-R	Regulator	VR303	SV120MA0094	Push Control	F1(Except for (M,MC))	Δ KB42C0071A	250V 7.500mA
Q302	2SD2437	LED Driver	VR304	2SD120N11	Push Control	F2(Except for (M,MC))	Δ KB42C1070	250V 71A
Q303	2SD1338-T	PS Amp.	SWITCHES					
DIODES			S201,202	EVGPR04K	Speed Selector			
D1	Δ SVG198A102	Rectifier	S400	SF02S075L13	Start/Stop			
D2	MA101	5.1V Zener	S401	SF02S075L-C	Stop/Resume			
S201,202	SVGPR39025-9	Speed Indicator	S600	SF02S05SL13P	Power			
S203-206	SVGSLH4V73	Switch	S602	SF02S090217	Voltage Selector			
S207A	MA101A	Switching						
S208	MA101	5.1V Zener						
S209	\otimes SVGSL19S2	Push Indicator						

fabrik
→ snelheidsindic

Ref. No.
 Chassis
 1
 2
 3
 4
 5
 6
 7
 8
 9
 10
 11
 12
 13
 14
 15
 16
 17
 18
 19
 20
 21
 22
 23
 24
 25
 26
 27
 28
 29
 30
 31
 32
 33
 34
 35
 36
 37
 38
 39
 40
 41
 42
 43
 44
 45
 46
 47
 48
 49
 50
 51

SL-1200MK2/1210MK2



Ref No.	Part No.	Description	Ref No.	Part No.	Description	Ref No.	Part No.	Description
CHASSIS AND CHASSIS PARTS								
1	SFAC12-01A	Door Cover (1)	52	SFQC12-02B	Insulator (4)	N31	WVG3P2	Washer (1)
2	SF7012-01E	Turntable Mtg (1)	54	SF7012-02E	Button, Speed (4)	N32	XSX3+149V	Washer (4)
3	SF7112-01	Turntable Flusher Assy (1)	55(M)	SF7N12251S	Name Plate (1)	N33	XKX3B2	Washer (1)
4	SFUM12-05	Cover, Cabinet (1)	56(M)	SF7N12251S	Name Plate (1)	N34	SFAG326-1	Screw (1)
5	SFMA320-01	Cover, Drive Coil (1)	57(M)	SF7N12251S	Name Plate (1)	N35	XSX3+85	Screw (2)
6	SFMA320-01A	Drive Coil Assy (1)	58(M)	SF7N12251S	Name Plate (1)	N36	KUC3PT	Orlop (1)
7	SFMA212-01E	PG Coil Assy (1)	59(XA)	SF7N12251S	Name Plate (1)	N37	SFPH12250	Screw (1)
8	SFMC220-01A	Shaft Assy, Turntable (1)	60(M,PA,PC)	SF7N12251S	Name Plate (1)	N38	KTN3+208	Screw (1)
9	SFAC12-01	Cabinet (Turntable area)	61(M,PA,PC)	SF7N12251S	Name Plate (1)	N39	SFPH+100	Washer (1)
10	SFAC124001	Cabinet (Shell) (EQ,EDC)	62	SF7N12251S	Name Plate (1)	N40	XSX3+88V5	Washer (4)
11	SFUM12-04	Ornament, Styling (1)	63	SF7N12251S	Name Plate (1)	N41	KWG3P2	Washer (1)
12	SF7K12-01	Humistor (1)	64	SF7N12251S	Name Plate (1)	N42	XSX3+129V5	Screw (1)
13	SF7K12-01E	Knob, Power Switch (1)	65	SF7N12251S	Name Plate (1)	N43	KWG3P2	Washer (1)
14	SF7K12-01E	Cass, Slide Humistor (1)	66	SF7N12251S	Name Plate (1)	N44	SF7N122-02	Washer (1)
15	SF7K12-01E	Button, Start/Stop (1)	67	SF7N12251S	Name Plate (1)	N45	SF7N122-01	Washer (1)
16	SF7K12-01E	Spring, Start/Stop Button (1)	68	SF7N12251S	Name Plate (1)	N46	KTN3+80	Screw (1)
17	SF7K12-01E	Button, Speed (1)	TONEARM PARTS			ACCESSORIES		
18	SF7K12-01E	Connector, Typ (1)	69	SF7K1201A	Headshell (1)	M30	SF7U12206	Instruction Book (1)
19	SF7K12-01E	Spacer, Rubber (1)	70	SF7K1202A	Tracearm Assy (Silver) (1)	M31(B,BC)	SF7U12206	Instruction Book (1)
20	SF7K12-01E	Ball, Spring Cam (1)	71	SF7K1203A	Tracearm Assy (Black) (1)	M32	SF7U12207	Instruction Book (1)
21	SF7K12-01E	Switch, Cam (1)	72	SF7K1204A	Balance Weight (1)	M33	SF7U12207	Instruction Book (1)
22	SF7K12-01E	Carb, Power Switch (1)	73	SF7K1205A	Lift Assy (1)	M34	SF7U12207	Instruction Book (1)
23	SF7K12-01E	Sealer, Speed Indicator (1)	74	SF7K1206A	Knob, Arm Base Lock (1)	M35	SF7U12207	Instruction Book (1)
24	SF7K12-01E	Cover, Stylus Humistor (1)	75	SF7K1207A	Knob, Arm Lift (1)	M36	SF7U12207	Instruction Book (1)
25	SF7K12-01E	Base, Drive (1)	76	SF7K1208A	Oil Damper (1)	M37	SF7U12207	Instruction Book (1)
26	SF7K12-01E	Spring, Drive Base (1)	77	SF7K1209A	Plate, Arm Base Cover (1)	M38	SF7U12207	Instruction Book (1)
27	SF7K12-01E	Pin, Lock Connector (1)	78	SF7K1210A	Sealer, Photo Cord (1)	M39	SF7U12207	Instruction Book (1)
28	SF7U12-02E	Bracket, Stylus Humistor (1)	79	SF7K1211A	Tracearm Flang Plate (1)	M40	SF7U12207	Instruction Book (1)
29	SF7U12-03	Plate, Lock Operation (1)	80	SF7K1212A	Plate (1)	M41	SF7U12207	Instruction Book (1)
30	SF7U12-03E	Connector, Spin (1)	81	SF7K1213A	Photo Cord (1)	M42	SF7U12207	Instruction Book (1)
31	SF7K12-01E	Pin, Guide (1)	82	SF7K1214A	Ground Wire (1)	M43	SF7U12207	Instruction Book (1)
32	SF7K12-01E	Lock, Connector (1)	83	SF7K1215A	Arm Rest (1)	M44	SF7U12207	Instruction Book (1)
33	SF7K12-01E	Spring, Lock Operation (1)	84	SF7K1216A	Arm Base (Silver) (1)	M45	SF7U12207	Instruction Book (1)
34	SF7U12-05	Pin, Lock Operation (1)	85	SF7K1217A	Arm Base (Black) (1)	M46	SF7U12207	Instruction Book (1)
35(M,PA,PC)	SF7K1205	Clamp, AC Cord (1)	86	SF7K1218A	Ring Arm Base Operation (1)	M47	SF7U12207	Instruction Book (1)
36(M)	SF7K1205	Clamp, AC Cord (1)	87	SF7K1219A	Bracket, Arm Base (1)	M48	SF7U12207	Instruction Book (1)
37(M)	SF7K1205	Clamp, AC Cord (1)	88	SF7K1220A	Knob, Anti-Slipp (1)	M49	SF7U12207	Instruction Book (1)
38(M)	SF7K1205	Clamp, AC Cord (1)	89	SF7K1221A	Cap (Silver) (1)	M50	SF7U12207	Instruction Book (1)
39(M)	SF7K1205	Bracket, AC Cord (1)	90	SF7K1222A	Cap (Black) (1)	PACKING PARTS		
40(M)	SF7K1205	Bracket, AC Cord (1)	SCREW NUT AND WASHERS			M1(M)	SF7U12208	Carton Box (Silver) (1)
41	SF7K12-02	AC Cord (1)	N1	KTN3+88P2	Screw (1)	M2	SF7U12208	Carton Box (Black) (1)
42	SF7K12-03	AC Cord (1)	N2	XSX3+55	Screw (1)	P2	SF7K12-01	Pad, Front (1)
43	SF7K12-03	AC Cord (1)	N3	KTN3+88	Screw (1)	P3	SF7K12-02	Pad, Top (1)
44	SF7K12-03	AC Cord (1)	N4	XSX3	Washer (1)	P4	SF7K12-03	Pad (A), Turntable (1)
45	SF7K12-03	AC Cord (1)	N5	KTN3+55	Screw (1)	P5	SF7K12-04	Pad (B), Turntable (1)
46	SF7K12-03	AC Cord (1)	N6	KTN3+88F4	Screw (1)	PT	SF7K12-05	Polyethylene Bag (1)
47	SF7K12-03	AC Cord (1)	N7	SF7K12-01	Screw (1)	P6	SF7K12-06	Units, Dust Cover (1)
48	SF7K12-03	AC Cord (1)	N8	KTN3+5J	Screw (1)	P7	SF7K12-07	Turntable (1)
49	SF7K12-03	AC Cord (1)	N9	SF7W12-01	Washer (1)	P8	SF7K12-08	Polyethylene Bag (1)
50	SF7K12-03	AC Cord (1)	N10	SF7W12-03	Washer (1)	P9	SF7K12-09	Polyethylene Bag (1)
51	SF7K12-03	AC Cord (1)	N11	XKX3E10	Washer (1)	P10	SF7K12-10	Polyethylene Bag (1)
52	SF7K12-03	AC Cord (1)	N12	XKX3B	Washer (1)	P11	SF7K12-11	Sheet Weight (1)
53	SF7K12-03	AC Cord (1)	N13	XKX3+105	Screw (1)	P12	SF7K12-12	Cover Sheet, Dual Cover (1)
54	SF7K12-03	AC Cord (1)	N14	SF7K1205E2	Washer (1)	P13	SF7K12-13	Cover Sheet, 45-Appltr (1)
55	SF7K12-03	AC Cord (1)	N15	KTN3+108	Screw (1)			Cover Sheet, Cards (2)
56	SF7K12-03	AC Cord (1)	N16	KTN3+108	Screw (1)			
57	SF7K12-03	AC Cord (1)	N17	KTN3+108	Screw (1)			
58	SF7K12-03	AC Cord (1)	N18	KUC3PT	Orlop (1)			
59	SF7K12-03	AC Cord (1)	N19	XSX17+3P	Screw (1)			
60	SF7K12-03	AC Cord (1)	N20	KUC3PT	Orlop (1)			
61	SF7K12-03	AC Cord (1)	N21	XSX3+145	Screw (1)			
62	SF7K12-03	AC Cord (1)	N22	KTN3-01	Orlop (1)			
63	SF7K12-03	AC Cord (1)	N23	XSX3+12	Screw (1)			
64	SF7K12-03	AC Cord (1)	N24	XSX3+85	Screw (1)			
65	SF7K12-03	AC Cord (1)	N25	KTN3+85	Screw (1)			
66	SF7K12-03	AC Cord (1)	N26	KTN3+147P2	Screw (1)			
67	SF7K12-03	AC Cord (1)	N27	SF7K12-03	Screw (1)			
68	SF7K12-03	AC Cord (1)	N28	SF7K12-01	Screw (1)			
69	SF7K12-03	AC Cord (1)	N29	KTN3+142P2	Screw (1)			

■ EXPLODED VIEWS

• Cabinet and Chassis Parts

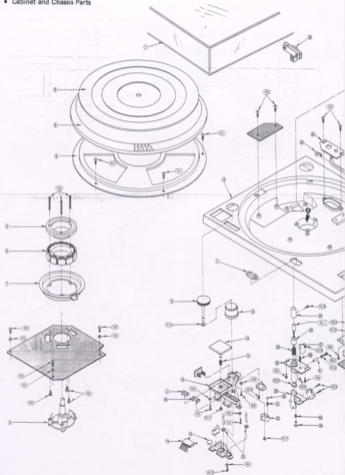

Note: For the set with serial number sheet change mark , the power transformer is fitted as shown below.

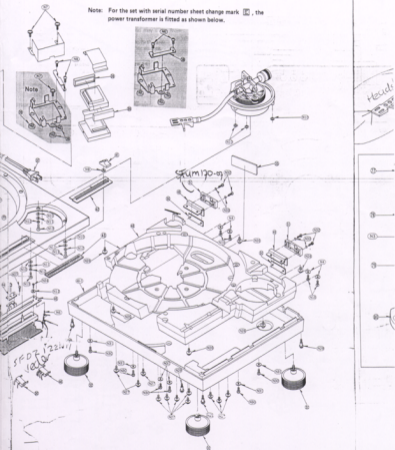

■ E • Tonarm Parts

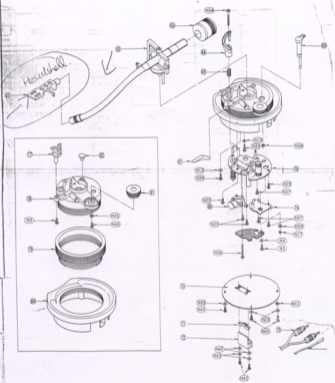

1200MK2/1210MK2

RSGN.

CIRCUIT BOARD AND WIRING CONNECTION DIAGRAM

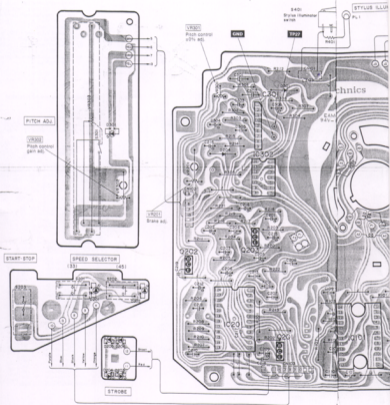

SL-1200MK2/1210MK2

GENERATOR

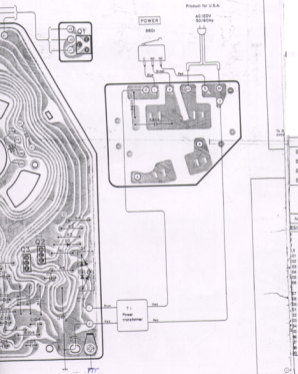

SL-1200MK2/1210MK2

- Power source circuit
- * Product for Canada

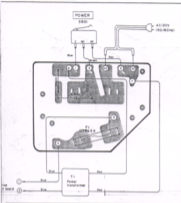

- * Product for [E], [EK], [XL], [EG], [EB], [EH], [EF], [EI], [XA], [PA], [PE] and [PC] areas

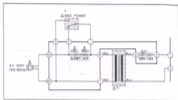
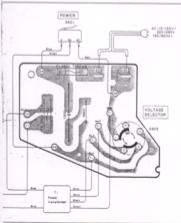

- Product for MC only

FUSE REPLACEMENT

 Symbol located near the fuse indicates fast operating type. For continued protection against fire hazard, replace with same type fuse. Refer to the symbol for fuse rating.

FUSIBLE REMPLACEMENT



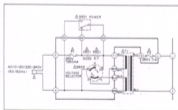

 Le symbole qui se trouve près du fusible signifie un fusible à action rapide. Pour une protection conçue contre les risques d'incendie, n'utiliser que des fusibles du même type. Se rapporter au symbole pour la valeur des fusibles.



■ SCHEMATIC DIAGRAM

(This schematic diagram may be modified at any time with the development of new technology.)













Notes:

1. S201, 202 : Speed selector switch.
2. S203 : Start/stop switch.
3. S301 : Pitch control reset switch in "off" position.
4. S401 : Stylus illuminator switch in "off" position.
5. S601 : Power switch in "on" position.
6. S602 : Voltage selector in "220 - 240" position.
7. The voltage value, and waveforms are the reference voltage value of this unit measured by DC electronic voltmeter (high-impedance) and oscilloscope on the basis of chassis. Therefore, the voltage value and waveform may include some error due to the internal impedance of the tester or the measuring set.
 - *  is the voltage when turntable is in stop.
 - *  is the voltage when turntable is in rotation. (at 33 rpm)
8.  +B voltage line.
9. Important safety notice.
Components identified by  mark have special characteristics important for safety. When replacing any of these components, use only manufacturer's specified parts.
10. The part No. of diodes mentioned in the schematic diagram stand for production part No. Regarding the part No. with  mark the production part No. are different from the replacement part No. Therefore, when placing an order for replacement part, please use the part No. in the replacement parts list.

IMPORTANT SAFETY NOTICE

The shaded area on this schematic diagram incorporates special features important for protection from fire and electrical shock hazards. When servicing it is essential that only manufacturer's specified parts be used for the critical components in the shaded areas of the schematic.

• Terminal guide of transistors, diodes and IC's

■ PACKING

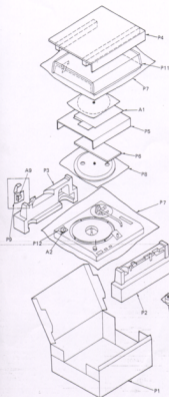

Headset
A3, A4, A5
A6, A8, P9

A7
P9

A10
P10
Counterweight
P9

1. Place the unit (with cushions attached) as illustrated.
2. Fold the flaps according to the line marks.
3. Seal the top with adhesive tape.
* Use gum tape or adhesive cloth tape of 50mm wide at least.
4. For the edges, first fold the flap "a" and then flap "b", and staple. Remember to staple only flap "b". (Use 15 or 16mm staple)

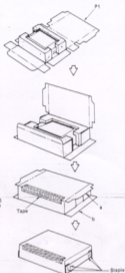

* Stapling positions are shown below.

